

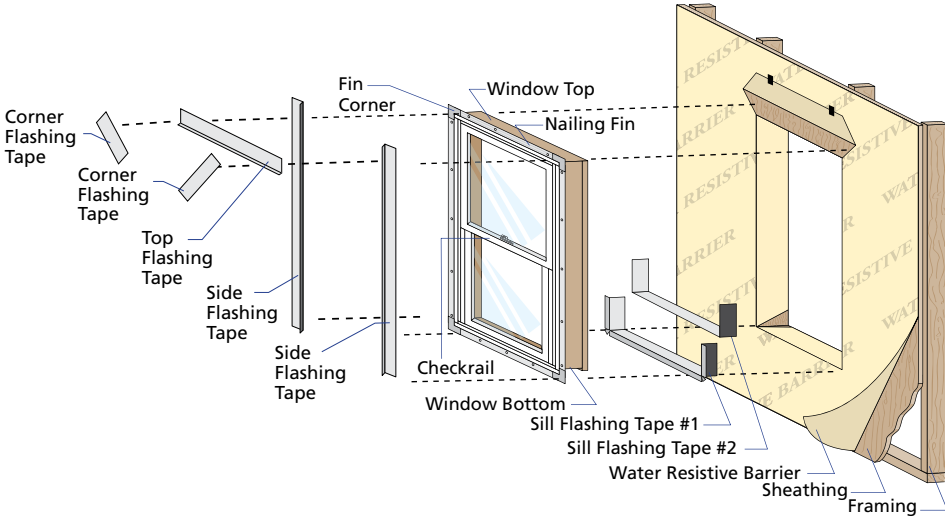

INSTALLATION INSTRUCTIONS - INSTRUCCIONES DE INSTALACION FOR HURRICANESHIELD® IMPACT-RESISTANT DOUBLE-HUNG, SINGLE-HUNG AND SIMULATED-HUNG

Instrucciones en español en el reverso.



Always read the Pella™ Limited Warranty before purchasing or installing Pella products. By installing this product, you are acknowledging that this Limited Warranty is part of the terms of the sale. Failure to comply with all Pella installation and maintenance instructions may void your Pella product warranty. See Limited Warranty for complete details at <http://www.pella.com>.

Important Safety Information:







Pella® HurricaneShield® Products have been tested in accordance with the large missile impact testing requirements of ASTM E 1886 and ASTM E 1996. Pella HurricaneShield Products are neither hurricane proof nor are they shatter proof. Severe wind and rain may produce temporary conditions which exceed product performance standards. When these units are subjected to intense storms or extreme conditions, which exceed the intended design pressures, air, water and flying debris infiltration may occur.

The performance of any building is dependent upon the design, installation, and workmanship of the entire building system. Pella Corporation strongly recommends consulting an experienced architect, contractor, or structural engineer prior to installation of Pella products.



The individual (building owner, architect, contractor, installer and/or consumer) responsible for the project must take into account local conditions, building codes, inherent component limitations, the effects of aging and weathering on building components, and other design issues relevant to each project.

The determination of the suitability of all building components for each project, as well as the design and installation of flashing and sealing systems, are the responsibility of the building owner, architect, contractor, installer and/or consumer.

YOU WILL NEED TO SUPPLY:

- Cedar or Impervious shims/spacers (12 to 20) 
- 2" galvanized roofing nails (1/4 lb.) 
- #10 x 3" corrosion resistant flat head wood screws or equivalent screws for concrete applications 
- Closed cell foam backer rod/sealant backer (12 to 30 ft.) 
- Pella® SmartFlash™ foil backed butyl window and door flashing tape or equivalent 
- High quality exterior grade polyurethane or silicone sealant (1 tube per window) 
- Great Stuff™ Window and Door Insulating Foam Sealant by the Dow Chemical Company or equivalent low pressure polyurethane window and door foam - DO NOT use high pressure or latex foams 
- Interior trim and/or jamb extensions (15 to 40 ft.)

INSTALLATION CLIP OPTION:

- 6" or 8" Installation clip 
- #6 x 5/8" corrosion resistant flat head wood screw 
- #8 x 1-1/4" corrosion resistant flat head or 3/16" x 1-1/2" masonry screws for concrete block applications 

TOOLS REQUIRED:

- Tape measure 
- Level 
- Square 
- Hammer 
- Stapler 
- Sealant gun 
- Scissors or utility knife 
- Stiff putty knife 
- Phillips screwdriver 
- Drill 
- Drill bits 13/64" and 1/8" 

REMEMBER TO USE APPROPRIATE PERSONAL PROTECTIVE EQUIPMENT.

1 ROUGH OPENING PREPARATION

A. Verify the opening is plumb and level.

Note: It is critical that the bottom is level.

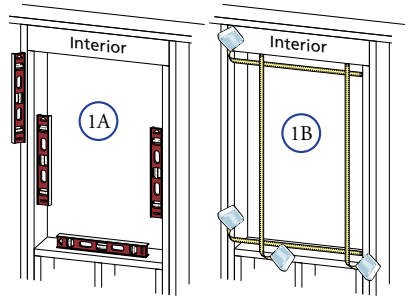

B. Verify the window will fit the opening.

Measure all four sides of the opening to make sure it is 1/2" larger than the window in both width and height. On larger openings measure the width and height in several places to ensure the header or studs are not bowed.

Note: 1-1/2" or more of solid wood blocking is required around the perimeter of the opening. Fix any problems with the rough opening before proceeding.

C. Cut the water resistive barrier (1C).

D. Fold the water resistive barrier (1D). Fold side flaps into the opening and staple to inside wall. Fold top flap up and temporarily fasten with flashing tape.

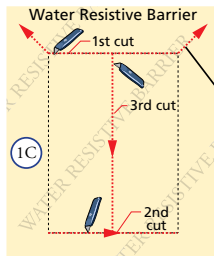

4th cut: Make a 6" cut up from each top corner at a 45° angle to allow the water resistive barrier to be lapped over the fin at the head of the window.

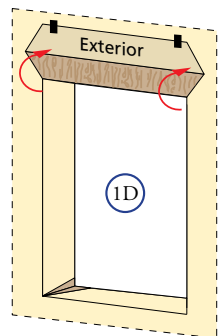

E. Apply sill flashing tape #1. Cut a piece of flashing tape 12" longer than the opening width. Apply at the bottom of the opening as shown (1E) so it overhangs 1" to the exterior.

Note: The tape is cut 12" longer than the width so that it will extend 6" up each side of the opening.

F. Tab the sill flashing tape and fold. Cut 1" wide tabs at each corner (1/2" from each side of corner) (1F). Fold tape to the exterior and press firmly to adhere it to the water resistive barrier.

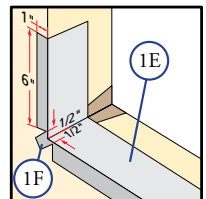

G. **Apply sill flashing tape #2.** Cut a piece of flashing tape 12" longer than the opening width. Apply at the bottom, overlapping tape #1 by at least 1". DO NOT allow the tape to extend past the interior face of the framing (1G).

Note: The flashing tape may not fully cover the framing members.

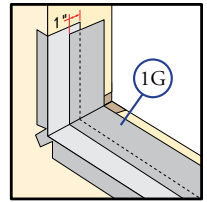

H. **Install and level sill spacers.** Place 1" wide by 1/4" thick spacers on the bottom of the window opening 1/2" from each side. Spacers are also required at points where windows are joined in multiple window applications. Add shims as necessary to ensure the spacers are level. Once level, attach spacers and shims to prevent movement.

Note: Improper placement of shims or spacers may result in bowing the bottom of the window.

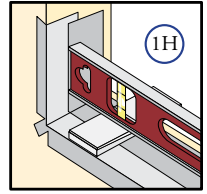

2 PREPARE THE WINDOW

A. **Remove plastic wrap and cardboard packaging from window.** DO NOT cut the checkrail bands or remove plastic shipping spacers located between the window sash and frame. The shipping spacers will help keep the window square during installation. DO NOT open the window until it is fully fastened.

Note: If screens, grilles or hardware are removed from the window at this time, label them and store them in a protected area.

B. **Fold out installation fin to 90°.** Be careful not to remove or tear the fin corners.

Note: If the fin is not at 90°, the window will not line up correctly on the interior.

Note: If installing the window using frame screws, proceed to Step 3 - SETTING THE WINDOW.

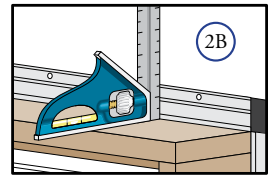

C. **Install installation clips.** Place the clip so that the lip is facing up and against the installation fin, at the locations shown in the placement diagram. Secure the clip by driving #6 x 5/8" corrosion resistant screws through the outer two holes of the three holes shown.

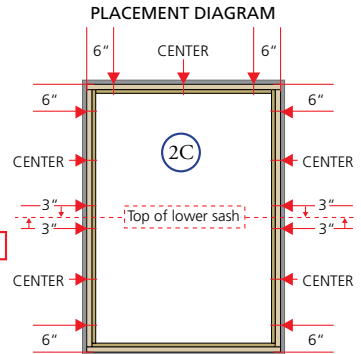
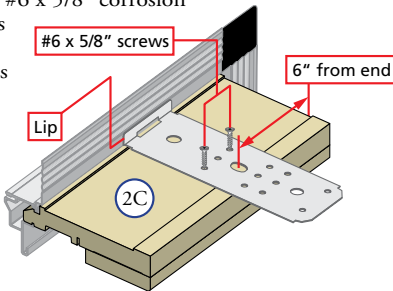

Note: ▲ Arrows indicate the placement of installation clips.

3 SETTING THE WINDOW

TWO OR MORE PEOPLE WILL BE REQUIRED FOR THE FOLLOWING STEPS.

A. **Insert the window from the exterior of the building.** Place the bottom of the window on the spacers at the bottom of the opening, then tilt the top into position. Center the window between the sides of the opening to allow clearance for shimming, and insert one roofing nail in the first hole from the corner on each end of the top nailing fin. These are used to hold the window in place while shimming it plumb and square.

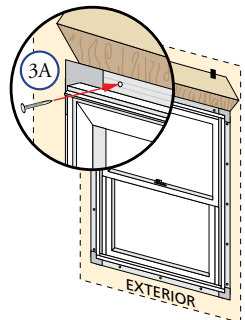

B. Plumb and square window.

Frame screw method: Place shims 1" from the bottom and top of the window between the window and the sides of the opening. Adjust the shims as required to plumb and square the window in the opening. Place shims at the midpoint of the window sides. Adjust the shims until the window sides are straight, and the space between the sash and frame is equal from top to bottom.

Installation clip method: Shim between the installation clip and the rough opening at each clip location.

Note: *DO NOT shim above the window or in the space between the spacers at the bottom of the window. DO NOT over shim.*

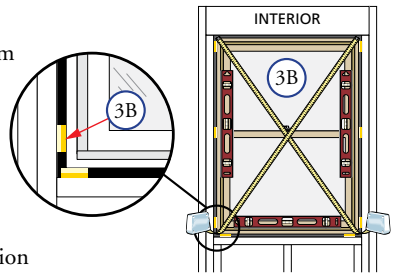

C. Check the interior reveal.

Make sure the measurement from the interior face of the window to the interior face of the wall is equal at several points around the window.

Note: *If the dimensions are not equal, check to make sure the fins are folded out to 90° at all points.*

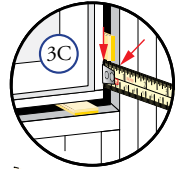

D. Fasten the window to opening

by driving 2" galvanized roofing nails into each pre-punched hole in the nailing fin.

Note: *Make sure the fin corner is lying as flat as possible.*

E. Check window operation (vent windows only).

Cut the checkrail bands and remove the shipping spacers. Open and close the window a few times to check for proper operation. Make sure the window will tilt correctly.

Note: *If there are any problems with the operation of the window, recheck shim locations and adjust for plumb and square.*

Note: *If installing the window using frame screws, proceed to Step 5 - FRAME SCREW METHOD.*

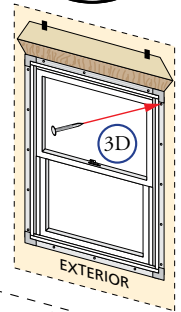

4 INSTALLATION CLIP METHOD

A. Fasten the window to the opening

by driving two #8 x 1-1/4" corrosion resistant screws into the pre-punched holes in the clips. If clips are bent and fastened to the interior stud/block, install the screws as close to the bend as possible.

Note: *DO NOT shim above the window. For masonry openings use two 3/16" x 1-1/2" masonry screws per clip. Pre-drill the masonry before attempting to drive the screws in.*

B. Simulated-hung only:

Remove the simulated-hung lock by removing the four screws from each lock.

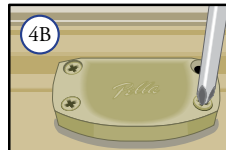

C. Raise the lower sash.

D. From the room side of the window,

drill 13/64" diameter clearance holes through the sill of the frame. Space the holes as shown.

E. Fasten the sill to the opening

by driving #10 x 3" corrosion resistant flat head wood screws into each of the pre-drilled clearance holes.

Note: *Drive the screws until snug but DO NOT over-tighten them. DO NOT bend or bow the unit frame.*

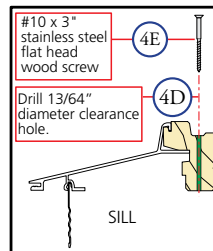

F. Simulated-hung only:

Close the lower sash and reinstall the lock(s).

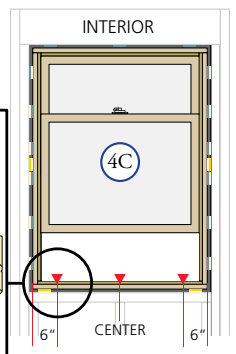
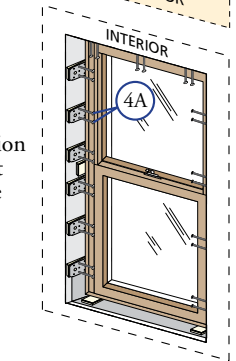

Note: *▲ Arrows indicate the placement of clearance holes.*

5 FRAME SCREW METHOD

- A. **Mark the location** of the top of the lower sash on the rough opening.

Note: Marking this location is needed for the correct placement of the frame screws.

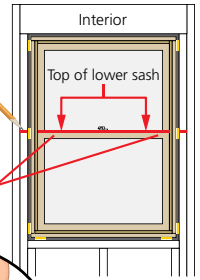

- B. **Simulated-hung only:** Remove the simulated-hung lock by removing the four screws from each lock.

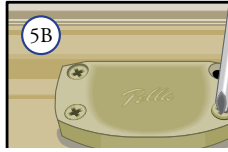

- C. **Remove the lower sash.** Raise the sash 6" or more and locate the two finger slides on the lower sash check rail. At the same time, slide each toward the center of the sash to disengage the wash lock stops and pull the sash towards the room side. The sash will tilt from the bottom.

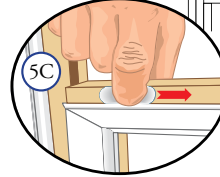

- D. **With the sash parallel to the floor,** lift one side of the lower sash until the terminal is removed from the balance shoe. Continue to lift the sash up until the terminal is released from the opposite side of the sash and can be removed from the shoe. Lift the sash up and out of the window frame. Set the sash in a safe location.

- E. **Simulated-hung and Single-hung only:** Remove the screw from the balance shoe in the jamb liner on both jambs.

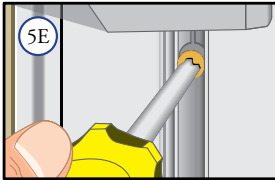

- F. **Remove the upper sash.** Lower the upper sash 6" or more and locate the two wash lock releases on the top of the sash. Slide each toward the center of the sash and pull the top of the sash to the room side.

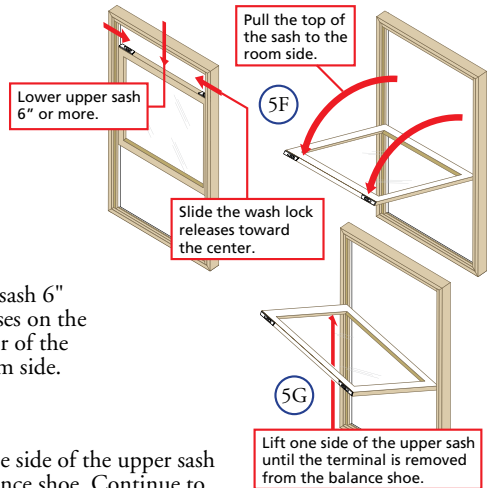

- G. **With the sash parallel to the floor,** lift one side of the upper sash until the terminal is removed from the balance shoe. Continue to lift the sash up until the terminal is released from the opposite side of the sash and can be removed from the shoe. Lift the sash up and out of the window frame. Set the sash in a safe location.

- H. **Remove the clad/wood insert.** Place a stiff putty knife under the weather-strip between the clad/wood insert and the vinyl on the interior side and gently pry the insert out of the jamb liner.

Note: On taller units, continue to pry up the length of the unit, if needed. Take care not to rip the weather-strip. The top of the insert is behind the head stop; use care in pulling it down from behind the stop so as not to dent the wood.

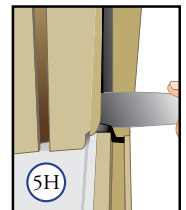

- I. **From the room side of the window, drill 13/64" diameter clearance holes through the head, jambs and sill of the frame.** Space the holes as shown.

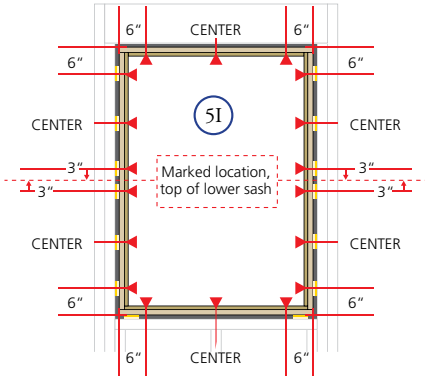

Note: ▲ Arrows indicate the placement of clearance holes.

- J. **Place shims at each pre-drilled clearance hole** between the window and the rough opening.
- K. **Drill 1/8" x 1" deep pilot holes** into the shims and rough opening through the clearance holes in the unit frame.
- L. **Fasten the window to the opening** by driving #10 x 3" corrosion resistant flat head wood screws into each of the pre-drilled clearance holes.

Note: Drive the screws until snug but DO NOT over-tighten the screws. DO NOT bend or bow the unit frame.

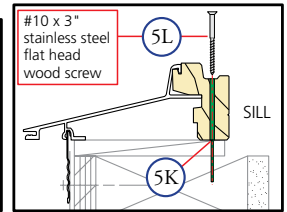
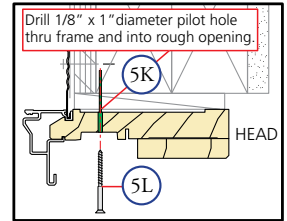
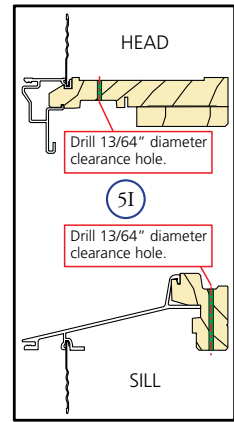
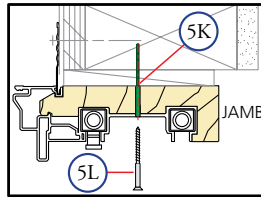

- M. Reinstall the clad/wood insert and sashes.

6 INTEGRATING THE WINDOW TO THE WATER RESISTIVE BARRIER

Note: The flashing tape must be applied approximately 1/2" onto the frame cladding at the jambs and head. Pre-folding the tape at 1/2" before removing the paper backing will make it easier to apply the tape correctly. If the siding is less than 1/2" thick, adjust the dimension of the fold so the exterior sealant line will cover the exterior edge of the tape.

- A. **Apply side flashing tape.** Cut two pieces of flashing tape 4" longer than the frame height of the window. Apply one piece 1/2" onto the window frame over the nailing fin and onto the water resistive barrier on each side. The tape should extend 2" above the top of the window and 2" below the bottom of the window. Press the tape down firmly while folding down the excess tape at the top and bottom of the window.

- B. **Apply top flashing tape.** Cut a piece of flashing tape long enough to go across the top of the window and extend at least 1" past the side flashing tape on both sides. Apply the tape 1/2" onto the window frame over the top nailing fin as shown. Fold the overlapping tape down, and press all tape down firmly.

Note: DO NOT tape or seal the bottom nailing fin.

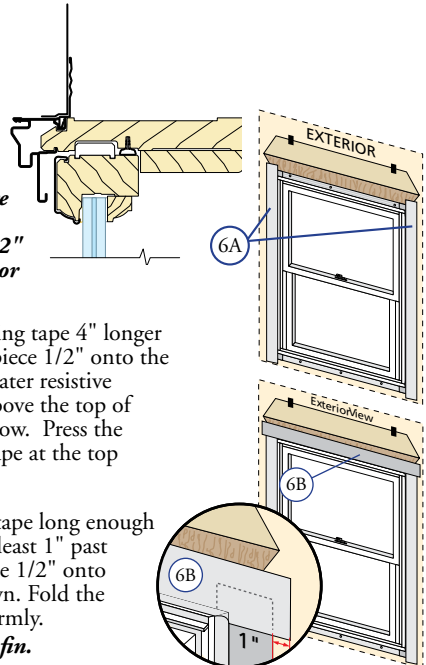

C. **Fold down top flap** of water resistive barrier (6C).

D. **Apply flashing tape to diagonal cuts.** Cut pieces of flashing tape at least 1" longer than the diagonal cuts in the water resistive barrier. Apply the tape covering the entire diagonal cut in the water resistive barrier at both upper corners of the window.

Note: Be sure to overlap the top corners (6D).

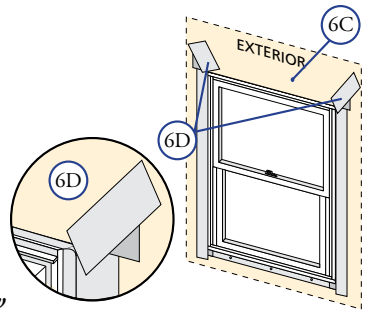

7 INTERIOR SEAL

Caution: Ensure use of low pressure polyurethane window and door insulating foam and strictly follow the foam manufacturer's recommendations for application. Use of high pressure foams or improper application of the foam may cause the window frame to bow and hinder operation.

A. **Apply insulating foam sealant.** From the interior, insert the nozzle of the applicator approximately 1" deep into the space between the window and the rough opening and apply a 1" deep bead of foam. This will allow room for expansion of the foam and will minimize squeeze out. If using foam other than Great Stuff™ Window and Door Insulating Foam Sealant by the Dow chemical Company, allow the foam to cure completely (usually 8 to 24 hours) before proceeding to the next step.

Note: DO NOT completely fill the space from the back of the fin to the interior face of the opening.

B. **Check window operation** (vent units only) by opening and closing the window.

Note: If the window does not operate correctly, check to make sure it is still plumb, level, square and that the sides are not bowed. If adjustments are required, remove the foam with a serrated knife. Adjust the shims, and reapply the insulating foam sealant.

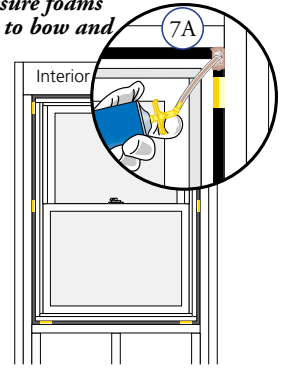

8 SEALING THE WINDOW TO THE EXTERIOR WALL CLADDING

When applying siding, brick veneer or other exterior finish material, leave adequate space between the window frame and the material for sealant. Refer to the illustration that corresponds to your finish material.

Note: The sealant details shown are standard recommendations from the sealant industry. Contact your sealant supplier for recommendations and instructions for these and any other applications.

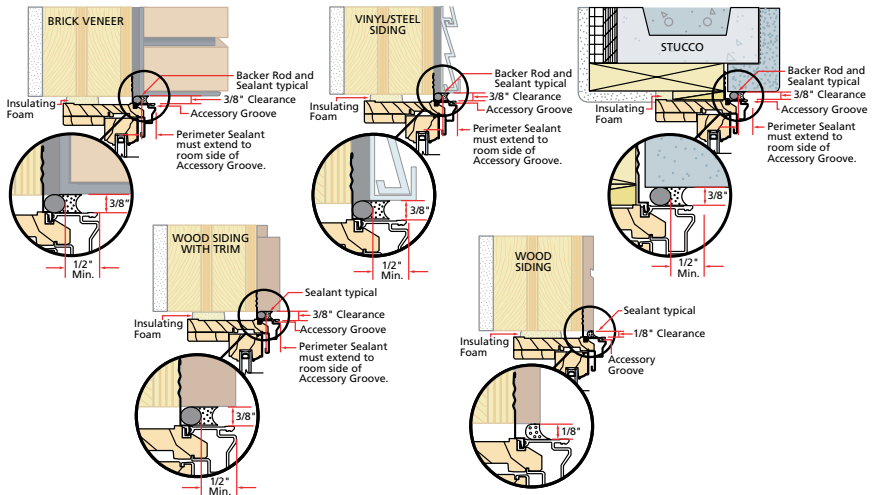

- A. **Insert backer rod** into the space around the window approximately 3/8". This should provide at least a 3/8" clearance between the backer rod and the exterior face of the window.

Note: Backer rod adds shape and depth for the sealant line.

- B. **Apply a bead of high quality exterior grade sealant** to the entire perimeter of the window.
- C. **Shape, tool and clean excess sealant.** When finished, the sealant should be the shape of an hourglass.

Note: This method creates a more flexible sealant line capable of expanding and contracting.

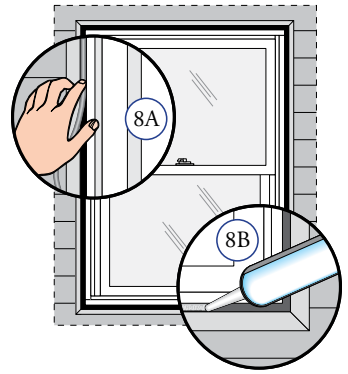

INTERIOR FINISHING

If products cannot be finished immediately, cover with clear plastic to protect from dirt, damage and moisture. Remove any construction residue before finishing. Sand all wood surfaces lightly with 180 grit or finer sandpaper. DO NOT use steel wool. BE CAREFUL NOT TO SCRATCH THE GLASS. Remove sanding dust.

Pella products must be finished per the below instructions; failure to follow these instructions voids the Limited Warranty.

- On casement and awnings, it is optional to paint, stain or finish the vertical and horizontal sash edges.
- On single-hung and double-hung, do not paint, stain or finish the vertical sash edges, any finish on the vertical sash edges may cause the sash to stick; it is optional to paint, stain or finish the horizontal sash edges.
- On patio doors, it is optional to paint, stain or finish the vertical and horizontal panel edges.

Note: To maintain proper product performance do not paint, finish or remove the weather-stripping, mohair dust pads, gaskets or vinyl parts. Air and water leakage will result if these parts are removed. After finishing, allow venting windows and doors to dry completely before closing them.

Pella Corporation is not responsible for interior paint and stain finish imperfections for any product that is not factory-applied by Pella Corporation. Use of inappropriate finishes, solvents, brickwash, or cleaning chemicals will cause adverse reactions with window and door materials and voids the Limited Warranty.

For additional information on finishing see the Pella Owner's Manual or go to www.pella.com.

EXTERIOR FINISH

The exterior frame and sash are protected by aluminum cladding with our tough EnduraClad® or EnduraClad Plus baked-on factory finish that needs no painting. Clean this surface with mild soap and water. Stubborn stains and deposits may be removed with mineral spirits. DO NOT use abrasives. DO NOT scrape or use tools that might damage the surface.

Use of inappropriate finishes, solvents, brickwash or cleaning chemicals will cause adverse reactions with window and door materials and voids the Limited Warranty.

CARE AND MAINTENANCE

Care and maintenance information is available in the Pella Owner's Manual. You can obtain an owner's manual by contacting your local Pella retailer. This information is also available on <http://www.pella.com>.

IMPORTANT NOTICE

Because all construction must anticipate some water infiltration, it is important that the wall system be designed and constructed to properly manage moisture. Pella Corporation is not responsible for claims or damages caused by anticipated and unanticipated water infiltration; deficiencies in building design, construction and maintenance; failure to install Pella products in accordance with Pella's installation instructions; or the use of Pella products in wall systems which do not allow for proper management of moisture within the wall systems. The determination of the suitability of all building components, including the use of Pella products, as well as the design and installation of flashing and sealing systems are the responsibility of the Buyer or User, the architect, contractor, installer, or other construction professional and are not the responsibility of Pella.

Pella products should not be used in barrier wall systems which do not allow for proper management of moisture within the wall systems, such as barrier Exterior Insulation and Finish Systems, (EIFS) (also known as synthetic stucco) or other non-water managed systems. Except in the states of California, New Mexico, Arizona, Nevada, Utah, and Colorado, **Pella makes no warranty of any kind and assumes no responsibility for Pella windows and doors installed in barrier wall systems. In the states listed above, the installation of Pella Products in barrier wall or similar systems must be in accordance with Pella's installation instructions.**

Product modifications that are not approved by Pella Corporation will void the Limited Warranty.